

# Dresser\* Series B3 Meter with ES3 Electronic Temperature Compensator AMR Version

Installation Supplement

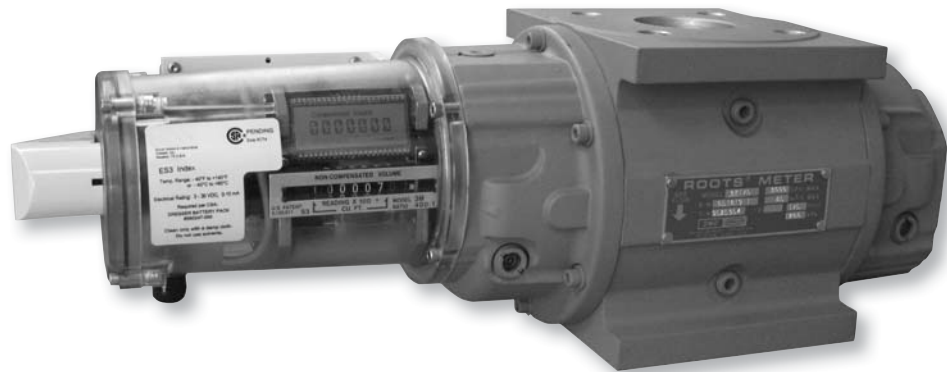

imagination at work

# ROOTS\* ES3 Electronic Temperature Compensator (TC) Installation Procedures

## Use and Limitations

This document provides recommendations where there is no established company procedure or practice.

WARNING
This equipment is designed to operate at temperatures between -40° F to 140° F. Prior to going on-site for installation or maintenance, make sure proper safety equipment is worn before handling the equipment and that you are properly dressed for the work site environment temperatures.

## Safety

The purchaser and user of this product is warned that compliance with the manufacturer's instructions and procedures is required in order to avoid the hazards of leaking gas resulting from improper installation, start-up or use of this product. The user is responsible to comply with all federal, state and local building and safety regulations. The manufacturer recommends that a qualified technician install this product for safe and proper operation.

Refer to "Installation Operation and Maintenance: ES3" (IOM) for complete instructions. Consult Factory to obtain the IOM.



## Receiving, Handling and Storage

Although of very rugged construction, reasonable care should be taken during handling and storage.

### At Time of Delivery

1. Check the packing list to account for all items received
2. Inspect each item for damage
3. Record any visible damage or shortages on the delivery record
  - a. File a claim with the carrier if necessary
  - b. Notify your Roots Meter supplier immediately

### IMPORTANT NOTE

**Do not attempt repairs or adjustments, as doing so may be a basis for voiding all claims for warranty.**

**The ES3 Electronic TC does not require lubrication.**

## 1. Meter Installation

Refer to "Installation Supplement IS:B3" for Meter installation procedures.

WARNING
If equipment is installed/serviced/maintained at elevated heights, ensure proper safe site work practices are in place to prevent fall and drop hazards.

WARNING
For installations in confined spaces, allow adequate room to safely handle product and equipment without causing bodily strain. Also verify proper ventilation is in place to maintain a breathable atmosphere.

## 2. LCD Display

Scrolling through the screen displays and connecting to the ES3 Electronic TC requires use of the magnet. The magnet can be purchased as part of the Communications Kit, P/N 060542-000 or as an individual item, P/N 060541-000. Consult Factory for pricing.

Swipe the magnet across the words "Roots ES3 Index" as shown in Figures 1 - 2.

**Note:** the magnet will not change screen displays if swiped on another area of the label.



Figure 1 - Label on ES3 Electronic TC

Figure 2 - Swipe magnet across the words "Roots ES3 Index" to change the screen displays

### 2.1 LCD Screen Displays

1. The default screen is either Compensated Volume or Non-Compensated Volume, depending on customer configuration.
  - a. This parameter is the home/default screen.
  - b. After a time out of approximately 30 seconds, the home screen always will appear.
2. Repeat the swiping motion of the magnet across the words "Roots ES3 Index," and the screens will appear in the sequential order as shown in Table 1.

**Note:** Using the Dresser MeterWare Software, the screens are configured by checking and un-checking the parameter to be displayed. Depending on the ES3 configuration, some screens may not appear.

**Table 1** - Scrolling sequence for ES3 screen display

Displayed on Screen	Represents	Function
COMPENSATED VOLUME	Compensated Volume	Displays non-compensated volume which has been corrected to standard conditions
NON-COMPENSATED VOLUME	Non-compensated Volume	Displays actual non-compensated volume
LINETEMP	Line Temperature	Displays live line temperature
FIXED P	Fixed Line Temperature	Displays the line pressure as entered by the user
FLOWRATE	Flow Rate	Displays uncorrected flow rate (average of latest 30 seconds of captured data)
MTR INFO	Meter Info	Meter size and type
PROVE CV	Compensated Prove Mode	Allows for compensated volume accuracy testing
PROVE UV	Non-compensated Prove Mode	Allows for non-compensated volume accuracy testing
BATTVOLT	Battery Voltage	Displays battery voltage
REM LIFE	Remaining Life	Calculated remaining battery life - shown in months
FIRM REV	Firmware Revisions	Displays the firmware revision that is in the ES3 at the present time
LCD TEST	LCD Test	Tests all display segments
BATTCHNG	Change Battery	Saves data to memory and resets clock
COMPFCTR	Compensation Factor	Displays the factor applied to non-compensated volume in order to arrive at compensated volume
COMPENSATED RESIDUAL	Compensated Residual	Shows extended compensated volume data beyond the value shown in the compensated volume screen
NON-COMPENSATED RESIDUAL	Non-compensated Residual	Shows extended non-compensated volume data beyond the value shown in the non-compensated volume screen
BASE T	Base Temperature	Displays base temperature as entered by the user
BASE P	Base Pressure	Displays base pressure as entered by the user
ATMOS	Atmospheric	Displays average atmospheric pressure as entered by the user
NCVOLFLT	Non-compensated volume under fault	Displays non-compensated volume that has accumulated since a fault occurred

3. Three to five seconds after the name of the value or the parameter appears, the screen will switch to show you the value of the selected parameter.
4. For an explanation of the data displays, refer to Section 2 of the "IOM:ES3 Installation Operation and Maintenance" manual. Consult Factory for a copy of the manual.

### 3. RPM Wheel

A high-speed RPM wheel is visible to the left of the digital display as shown in Figure 3.

The RPM wheel is tied directly to the meter impellers and is used to verify gas flow through the meter.

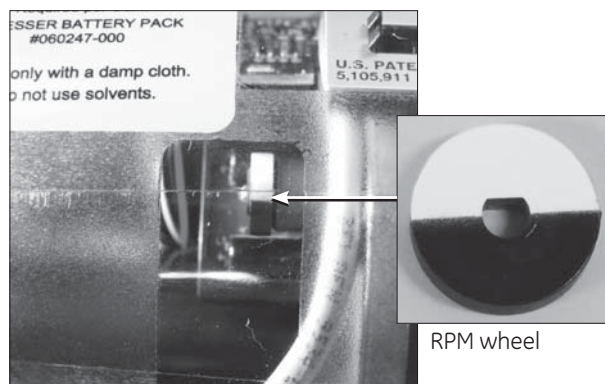

**Figure 3** - Movement of the RPM wheel indicates impeller rotation

#### 4. Wiring the Pulse Outputs

The ES3 Electronic TC provides pulse outputs from both an AMR cable output and a circular pulse output connector as shown in Figures 4 and 5. Reference Tables 2 and 3 for the appropriate wiring configuration outputs.

The pulse outputs are configurable utilizing the Dresser MeterWare software. For more information, consult the Dresser MeterWare manual.

**Note:**

The Circular mating connector is available with 5, 10 or 20 feet of cable. Contact Factory for price, part number and availability.

**WARNING**

Ensure properly licensed/trained professionals are used to install equipment if installed in hazardous locations containing explosive atmospheres. All local codes and standards shall be maintained during installation.

**WARNING**

Products certified as intrinsically safe installations shall be:

- Installed, put into service, used and maintained in compliance with national and local regulations and in accordance with the recommendations contained in the relevant standards concerning potentially explosive atmospheres.
- Used only in situations complying with the certification conditions shown in this document and after verification of their compatibility with the zone of intended use and the permitted maximum ambient temperature.
- Installed, put into service and maintained by qualified and competent professionals who have undergone suitable training for instrumentation used in areas with potentially explosive atmospheres.

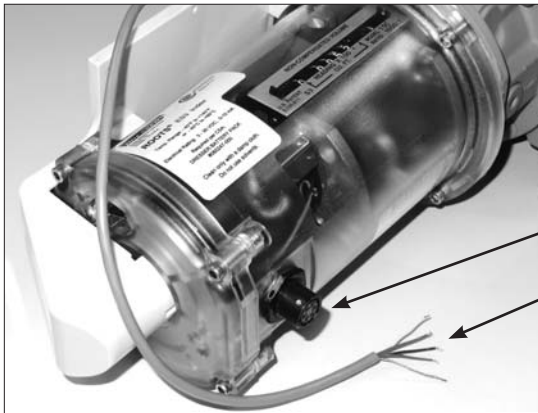

Figure 4 - ES3 with AMR cable

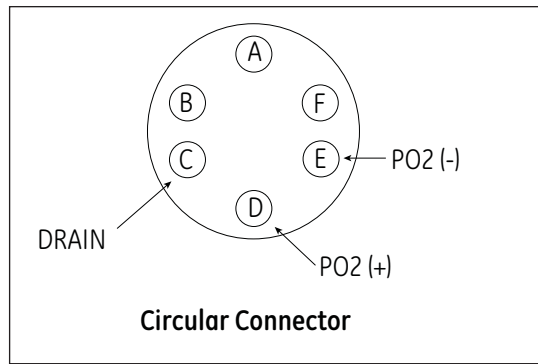

Figure 5 - Circular Connector

Table 2 - AMR wiring

Output	Name	Wire Color	Pulse Type
Pulse Output 1 (+)	PO1 (+)	White	Form A
Pulse Output 1 (-)	PO1 (-)	Black	
Drain	(Drain)	Bare Wire	—
Pulse Output 3 (+)	PO3 (+)	Red	Form B
Pulse Output 3 (-)	PO3 (-)	Green	

Table 3 - Circular Connector

Output	Name	Connector Pin	Pulse Type
Drain	(Drain)	C	—
Pulse Output 2 (+)	PO2 (+)	D	Form A
Pulse Output 2 (-)	PO2 (-)	E	

To maintain compliance with CSA certification, use a suitable Intrinsic Safety barrier for a Class 1 hazardous area for groups A, B, C and D:

1. Do not exceed the following input values for the barrier device:
  - a.  $V_i=8.2V$
  - b.  $I_i=1.5ma$
2. The OUTPUT and power handling capability of a barrier should not exceed:
  - a.  $V_{out}=30V$
  - b.  $I_{out}=50ma$

Refer to Figure 6 for proper wiring in hazardous locations.

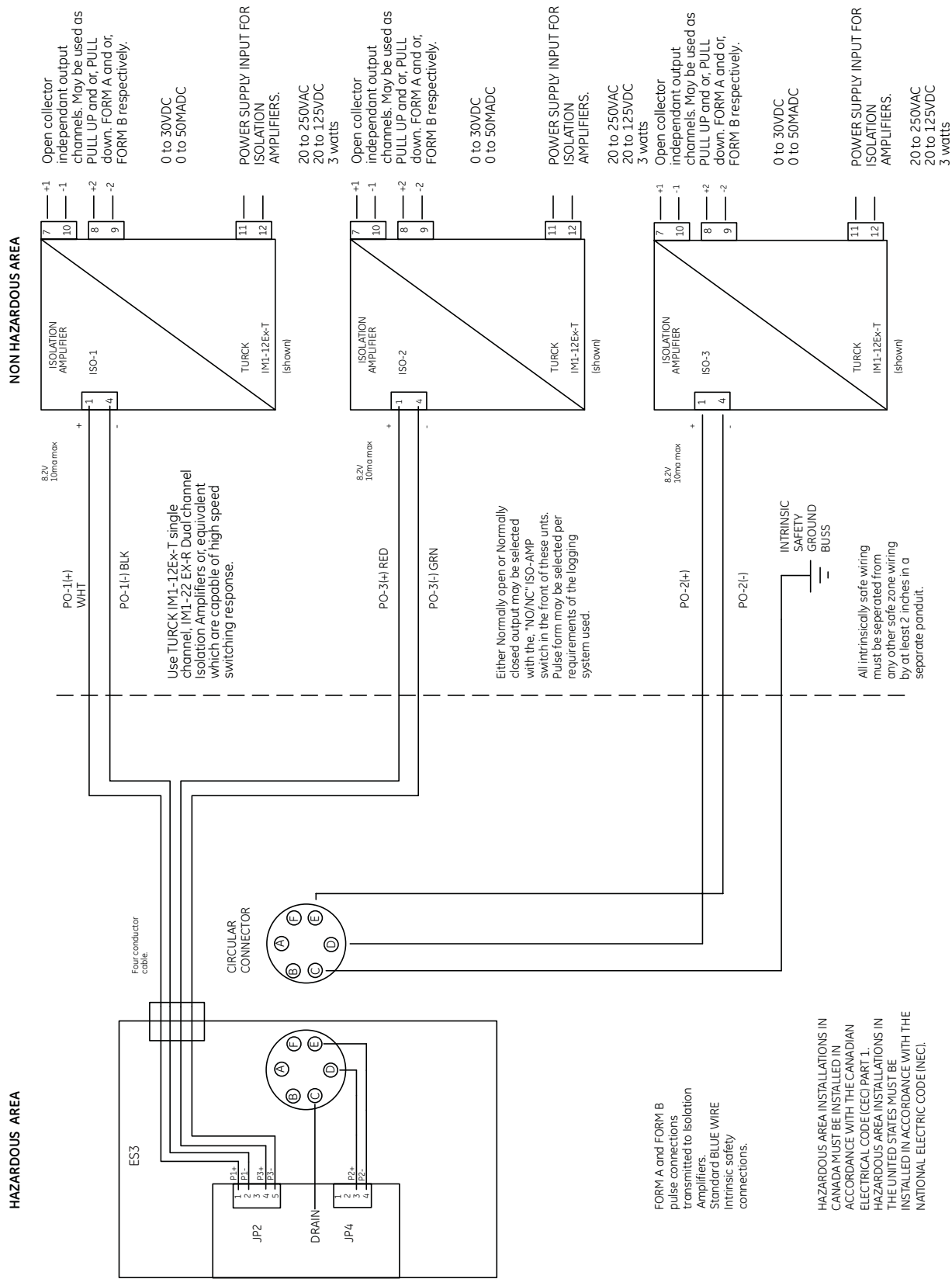

Figure 6 - Wiring Diagram for hazardous locations.



## 5. Changing AMR Bracket Inlet Orientation (if required)

When the ES3 Electronic TC arrives from the Factory, the AMR bracket is set for top inlet orientation, as shown in Figure 7, unless previously specified to the Factory.

**This section explains changing bracket inlet orientation if required.**

**Note:** The AMR bracket shown in Figure 7 is in the top inlet position; however, the next steps explain changing the bracket for both top and side inlet orientation.



Figure 7 - Top inlet orientation of AMR bracket

### 5.1. Remove AMR Bracket

- Using a 5/32" hex wrench, remove the two screws that hold the AMR bracket to the ES3 unit, as shown in Figure 8.
- Do not remove the screw that is under the odometer (see Figure 9), as it holds the ES3 unit to the meter while you remove the other short screw.
- Retain the three screws for re-attaching the AMR bracket.

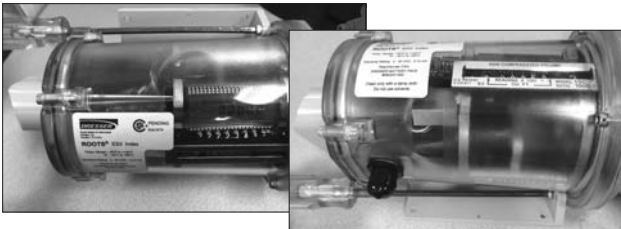

Figure 8 - Remove screws to AMR bracket



Figure 9 - Leave screw under odometer in place

### 5.2 Re-attaching the AMR Bracket

Note the location of the screw holes for top vs. side installation as shown in Figure 10.

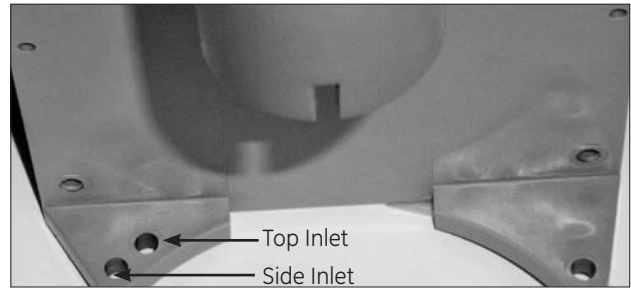

Figure 10 - Location of screw holes

#### Top Inlet Orientation:

- Align the AMR bracket; placing the cable gland connector into the recess on the end of the accessory unit, as shown in Figure 11.



Figure 11 - Place cable gland connector into recess

- Insert the two 1" (long) screws through the AMR bracket, and tighten with the 5/32" hex wrench until the bracket is in contact with the ES3 housing. Refer to Figure 12.

The other 1" screw will be mounted through the bracket opposite the screw shown in Figure 12

**Important:** Do not tighten at this point.



Figure 12 - Insert the 1" (long) screws  
1" screws (one not shown)

- C. Insert the remaining 3/4" (short) head screw into the open hole near the LCD display screen as shown in Figure 13. Do not tighten.

**Note:** If a security wire is required, the wire can be connected through this drilled head screw near the LCD display screen.



Figure 13 - Insert the 3/4" (short) screw

- D. Working in a cross pattern, tighten all screws to 14-16 inch-pounds using a torque wrench.

**Important:** Do not exceed this torque as damage may occur to the accessory unit cover at higher torque values.

**Side Inlet Orientation:**

- A. Align the AMR bracket, placing the cable gland connector into the recess on the end of the accessory unit, as shown in Figure 14.



Figure 14 - Place the cable gland connector into recess

- B. Insert the two 1" (long) screws through the AMR bracket, and tighten with the 5/32" hex wrench until the bracket is in contact with the ES3 housing. Refer to Figure 15.

The other 1" screw will be mounted opposite the screw shown in Figure 15.

**Important:** Do not tighten at this point.

**Note:** If a security wire is required, the wire can be connected through this drilled head screw near the LCD display screen.



Figure 15 - insert the 1" (long) screws  
1" screws (one not shown)

- C. Insert the remaining 3/4" (short) screw into the open hole on the back side of the unit as shown in Figure 16. Do not tighten.

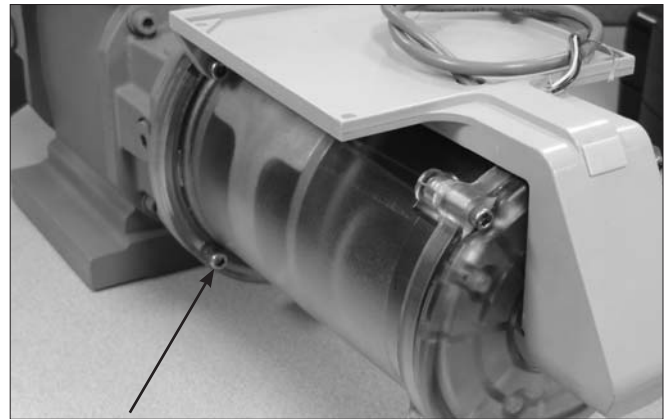

Figure 16 - Insert the 3/4" (short) screw

- D. Working in a cross pattern, tighten all screws to 14-16 inch-pounds using a torque wrench.

**Important:** Do not exceed this torque as damage may occur to the accessory unit cover at higher torque values

## 6. Proper Installation of an Itron Remote Gas Endpoint Device

Important: To successfully mount the AMR device to the AMR bracket:

1. The ES3 Electronic TC must be purchased as “AMR Ready.”
2. If necessary, the ES3 Electronic TC can be configured utilizing the Volume Configuration screen in the Dresser MeterWare software. Refer to Figure 17.

**Note:** Some customers will have the ES3 Electronic TC configured by the Factory. Verify your company policy prior to making any configuration changes.

**Note:** For more information on how to configure the unit, consult the Dresser MeterWare software manual.

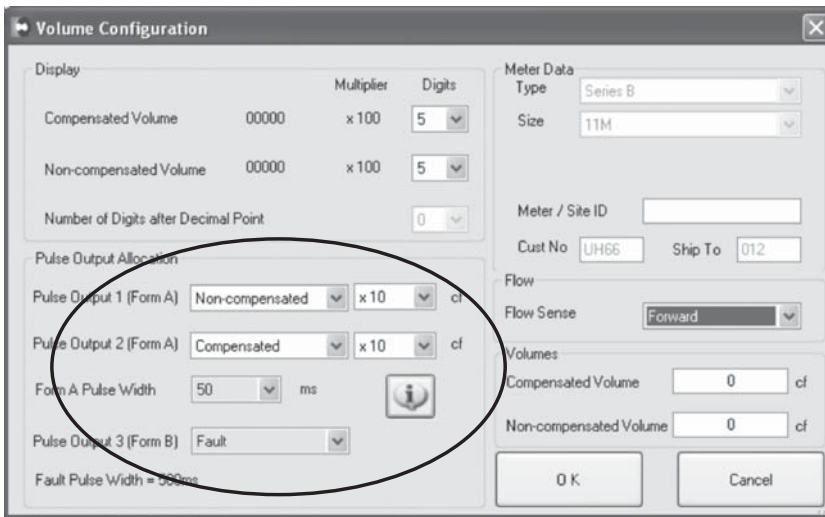

Figure 17- Volume Configuration screen in Dresser MeterWare software

To ensure pulse outputs are properly wired, the Dresser MeterWare software has a test function available on the Advanced screen, as shown in Figure 18.

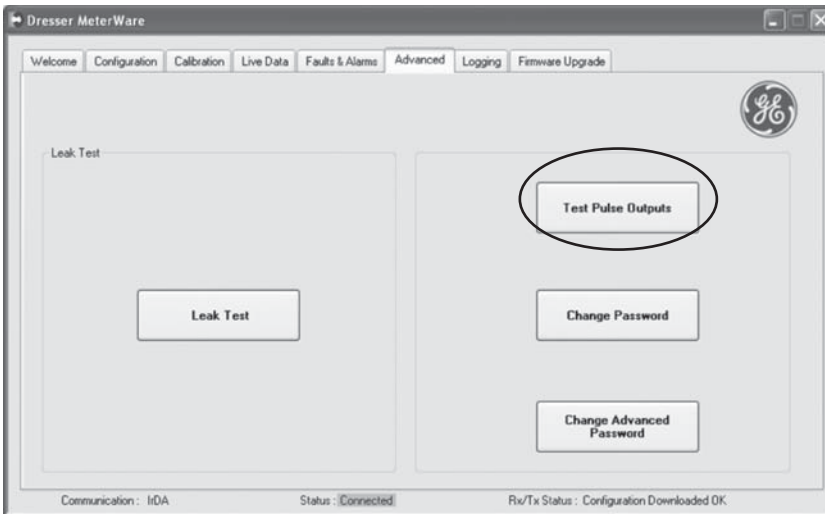

Figure 18- Advanced screen in Dresser MeterWare software

After clicking “Test Pulse Outputs,” a screen appears as shown in Figure 19. Click “Yes” to proceed with the pulse output test. For further information, refer to the Dresser MeterWare Manual.



Figure 19- Send test Pulses screen in Dresser MeterWare software



## 7. Wiring the Itron Remote Gas Endpoint Device to the ES3 Electronic TC

- A. Cut the cable and remove the vinyl, which will make for a cleaner and easier installation. Be careful not to damage the wires when removing the vinyl cover. See Figures 20 and 21. **Leave some cable available for any future changes to the AMR device.**

**Note:** You do not need to strip the wire as the Gel Cap splices supplied with the AMR are Insulation Displacing Connection (IDC) type connectors.

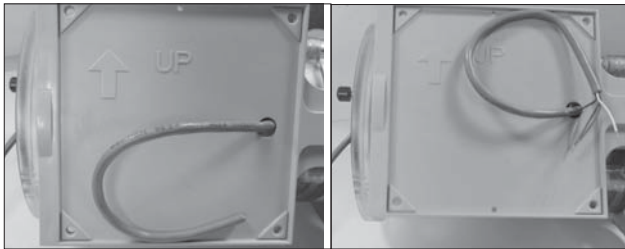

Figure 20 - Cut the AMR cable

Figure 21 - Remove vinyl

- B. Use appropriate crimping pliers to seal and splice the black ES3 wire to the red AMR wire and the white ES3 wire to the white AMR wire. See Figures 22 and 23.

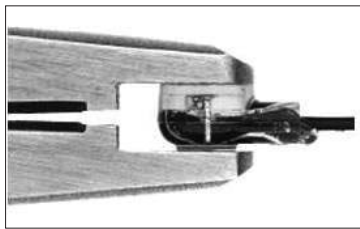

Figure 22 -Seal wire



Figure 23 -Splice wire

- C. Clip off the unused green, red and shield wires from the ES3 cabling and tuck all of the wires into the appropriate pocket in the back of the AMR. See Figures 24 and 25.

**Note:** Ensure the cable fits into an open pocket inside the ERT. The individual wires do not need to remain in a pocket since the walls of the pockets are lower than the outside walls of the housing and the mounting bracket has raised mounting points in the corners to prevent pinching of the individual wires.



Figure 24 -Clip unused wires

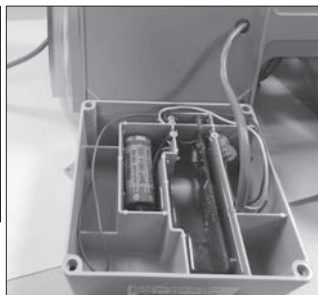

Figure 25 -Tuck extra cable into a pocket

- D. Use a T15 Torx screwdriver to attach the AMR to the ES3 AMR bracket. See Below.



Figure 26 - Attach AMR to ES3 bracket

## 8. Confirming Itron Remote Gas Endpoint Device is Properly Mounted

**Important:** Regardless of AMR model or meter orientation (side or top inlet) the bar code on the side of the AMR device must always face up, as shown in Figure 27. This puts the tilt/tamper switch in the proper orientation in the AMR.



Figure 27 - Bar code faces up.

- A. For side inlet, the AMR bracket is on top (or 90°) from the odometer, as shown in Figure 28.  
 B. For top inlet, the AMR bracket is directly opposite the odometer, as shown in Figure 29.

**Note:** Refer to Figure 10 for proper locations of the screws for top and side inlet orientation.

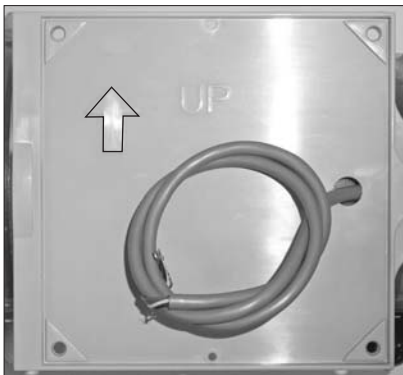

Figure 28 - Side inlet: notice the close positioning of the ES3 label to the bracket



**Figure 29** - Top inlet: notice the space between the ES3 label and the bracket

**Note:** When properly installed, whether top or side inlet, the arrow on the AMR mounting bracket will point up, away from the ground, as shown in Figure 30.



**Figure 30** - Correct orientation of mounting

**GE Oil & Gas**

16240 Port Northwest Drive, Suite 100

Houston, TX 77041

P: +1 832.590.2303 Inside US P: 800.521.1114

F: +1 832.590.2494 Inside US F: 800.335.5224

Visit us online at:

[www.ge.com/energy](http://www.ge.com/energy)

2012 General Electric Company

All Rights Reserved

\* Denotes a trademark of General Electric Company

